

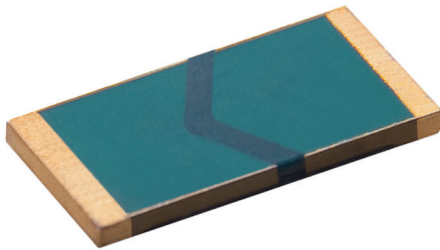

ISA-PLAN® // PRECISION RESISTORS



VMK-NA // Au-plated Size 1206



Features

- 1 W power rating at 110 °C
- Constant current up to 3 A (100 mOhm)
- Small size (1206)
- High pulse power rating
- Excellent long-term stability
- Mounting: conductive adhesive / soldering
- AEC-Q200 qualified
- RoHS 2011/65/EU compliant



Applications

- Current sensor for power hybrid applications
- Control systems for the automotive market
- Power modules
- Frequency converters
- Switch mode power supplies

Technical data

Resistance values	mOhm	100 *
Tolerance	%	1 *
Temperature coefficient (20-60 °C)	ppm/K	<20
Applicable temperature range	°C	-65 to +170
Power rating P_{110°C}	W	1
Power rating P_{80°C}	W	1.5
Internal heat resistance (R _{thi})	K/W	<60
Dielectric withstanding voltage	V AC/DC	200
Inductance	nH	<3
Stability (at rated power) deviation after 2000h, T _K = Terminal temperature		<0.5 % (T _K =80 °C) <1.0 % (T _K =110 °C)

* Further values and tolerances on request

Ordering code

VMK - R100 - 1.0 - NA

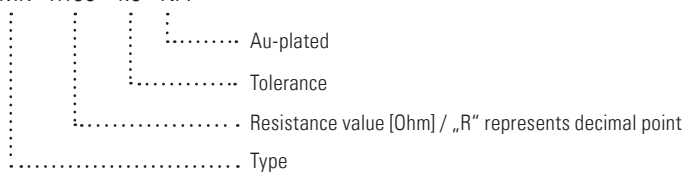



VMK-NA // Size 1206

Recommended solder profile

Reflow- and IR-soldering				
Temperature	°C	260	255	217
Time	sec	peak	40	90

Tape and reel information

Specification		DIN EN 60286-3		
Tape width	mm	8		
Reel size	inch	13		
Parts per reel	pcs	12500		
Packaging weight net	g	454		

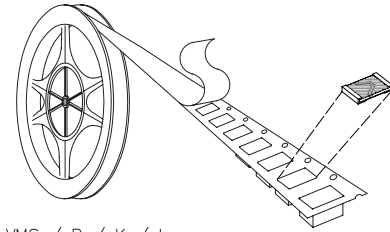

VMS / P / K / I

Specification (*parts tested at soldered condition)

Parameters	Test conditions	Specified values *
Temperature Cycling	2000 cycles (-55 °C to +150 °C)	±0.5 %
Low Temperature Storage	-65 °C for 250 h	±0.1 %
Resistance to Soldering Heat	260 °C for 10 sec / 8h steam aging	±0.3 %
Moisture Resistance	MIL-STD-202 method 106	±0.5 %
Mechanical Shock	100 g, 6 ms half sine	±0.2 %
Vibration, High Frequency	10 g, 10-2000 Hz, 24 h each axis	±0.2 %
Operational Life	2000 h, T _k max at rated power	±1.0 %, T _k = 110 °C
High Temperature Exposure	2000 h / 170 °C	±1.0 %
Bias Humidity	+85 °C, 85 r.F., 1000 h, powered	±0.5 %

Mechanical dimensions and pcb-layout proposal (Reflow-soldering) [mm] // drawing Z-YK-614b

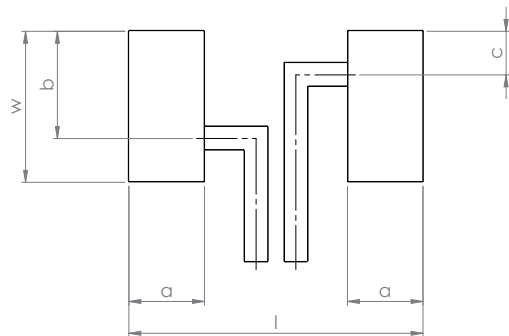
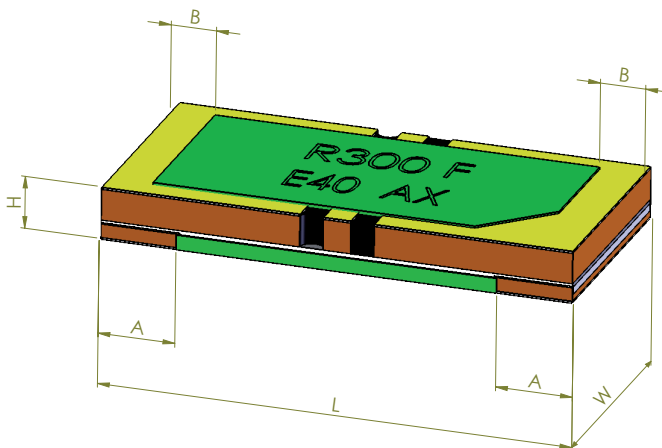

type:	L	W	H	A	B
VMK-NA	3.05 ±0.2	1.52 ±0.2	0.37 ±0.1	0.5 ±0.15	0.3 ±0.15

solder pad type:	l	w	a	b	c
VMK-NA	3.7	1.9	0.95	1.35	0.55



VMK-NA // Size 1206

Temperature dependence of the electrical resistance

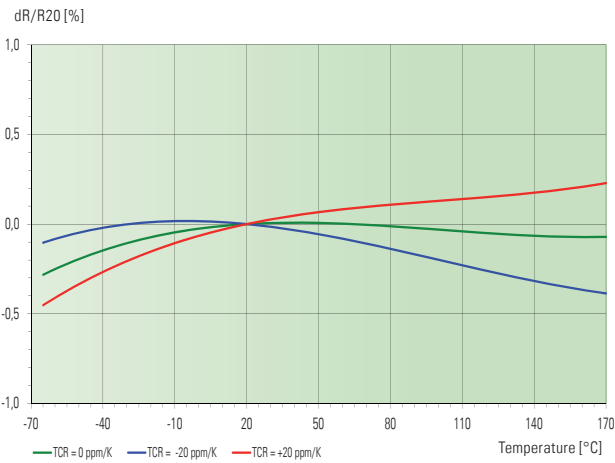

Power derating curve

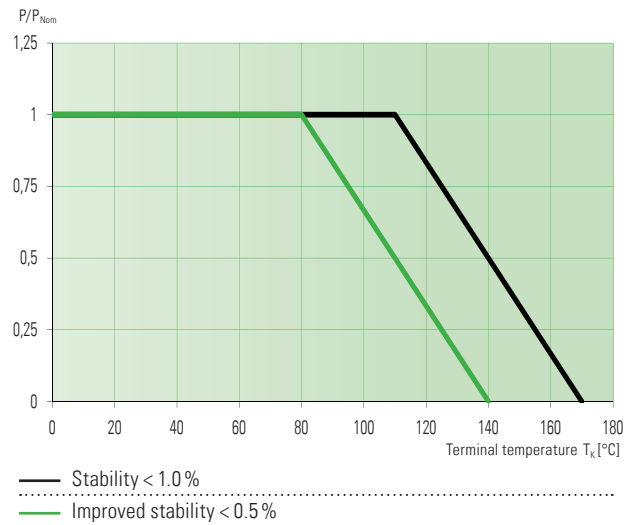

Maximum pulse energy respectively pulse power for permanent operation

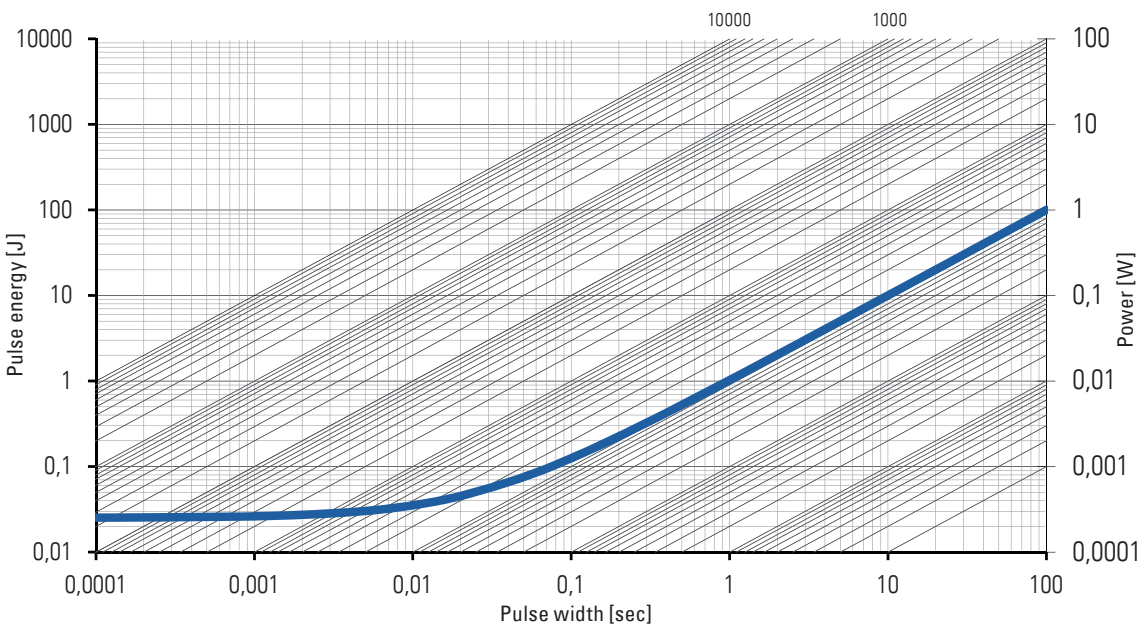

This curve is only valid for the resistance value R100. The shape of the curve in the range below 0.1 sec will be different for other resistance values. Therefore a separate qualification should be made for pulse power close to the above curve.

Disclaimer // All products, product specifications and data are subject to change without notice.

The product specifications do not expand or otherwise modify Isabellenhütte's terms and conditions of sale, including but not limited to, the warranty expressed therein. Isabellenhütte makes no warranty, representation or guarantee other than as set forth in its terms and conditions of sale. Information provided in data-sheets and/or specifications may vary from actual results in different applications. Any statements made by Isabellenhütte regarding the suitability of products for certain types of applications are based on its knowledge of typical requirements that are often placed on its products. It is the customer's responsibility to validate that a particular product with the properties described in the product specification is suitable for use in the application intended. No license, express or implied, or otherwise, to any intellectual property rights is granted by this document. Any and all liability arising out of the application or use of any product shall be as set forth in Isabellenhütte's terms and conditions of sale.

